



DA0521001Rev5

## ILLUSTRATED PARTS LIST AXLE

DATE: 28/04/2023



For Axle Models: D170FL, D190FL, D590FL

### Full Time Pump

---

**Note:** This IPL may need to be used together with the standard US Axle IPL (AXIP-0057) for any of the carrier and axle parts. See [www.dana.com.au](http://www.dana.com.au)

The only internal parts of the carrier which have changed from the standard axle (non-FTP) to the FTP axle, are the **Input Shaft, thrust washer** and the **Manifold Assembly**.  
The part numbers for these items are not in the AXIP-0057!

Description	FTP	AXIP-0057 (for <b>non</b> -FTP only)
Input Shaft	<b>10101209</b>	131349 (NSS) Kit:513840
Thrust Washer 	<b>132440-B</b>	<b>132440-B</b>
Manifold Assembly 	<b>131366AUS</b>	131366 (NSS) Kit:513878

## D170

---

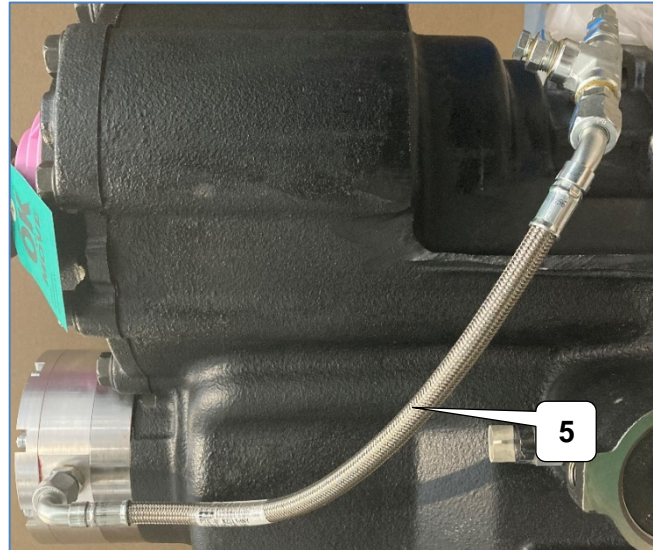
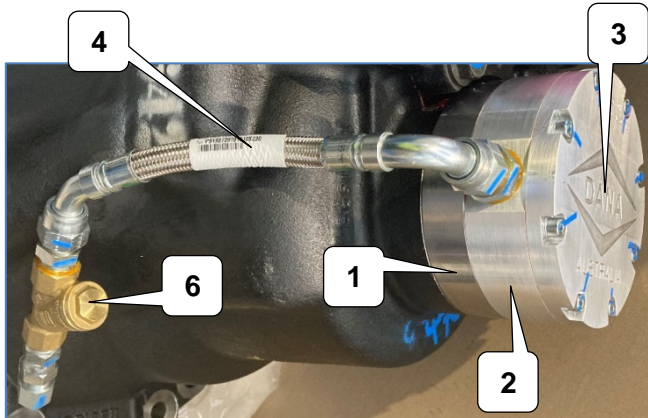

**Note:** If the Carrier Sub-Assy (Main housing) needs replacing, contact Dana for the part number.

## D190 / D590

---

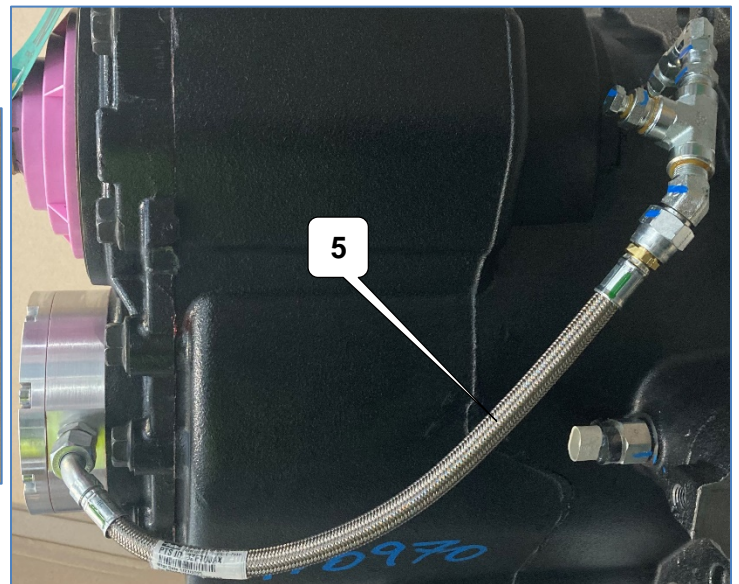
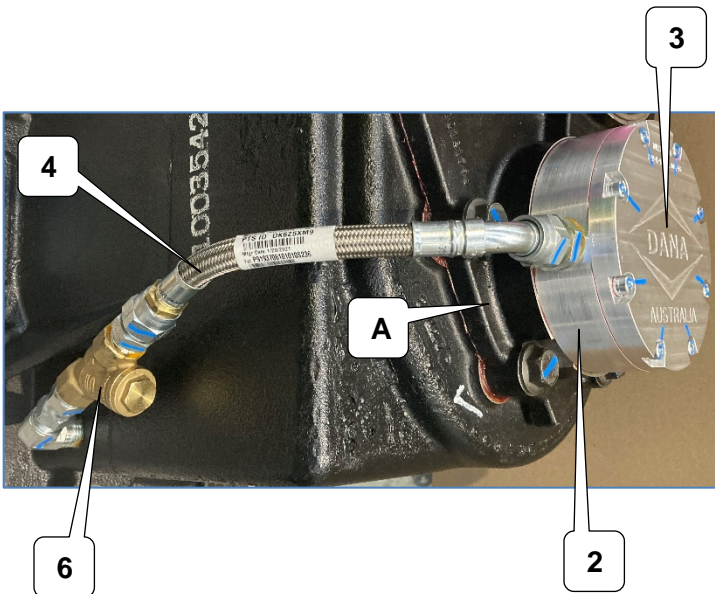

Item	Description	Qty Per Axle	Part Number		Notes
			D170	D190 / D590	
1	Pump Base	1	10112396	NA	
2	Pump Body	1	10112393		
3	Pump Cap	1	10112397		
4	Suction Hose Assy	1	10112380	10169757	
5	Pressure Hose Assy	1	10112370	10169758	
6	Strainer	1	10112385		
A	Input Cover		NA	10181796	

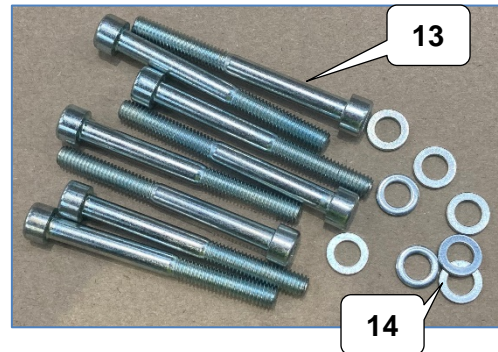
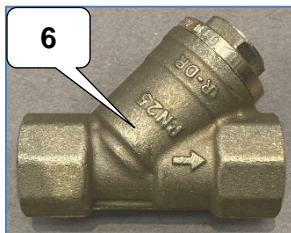
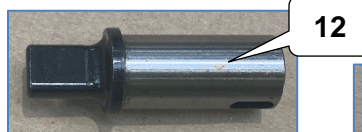
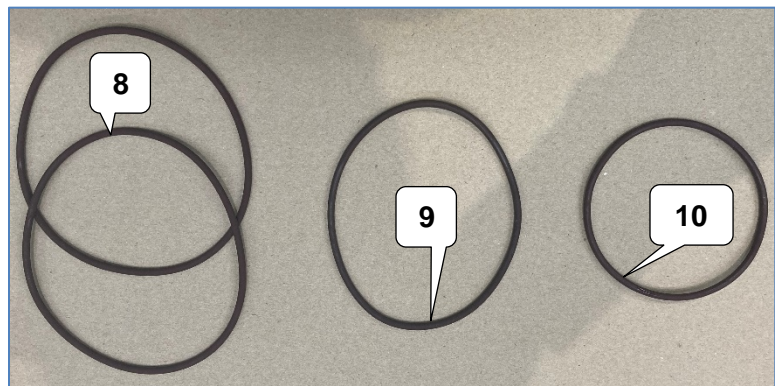



Item	Description	Qty Per Axle	Part Number	Notes
			D170 / D190 / D590	
7	Gear pump assy.	1	PWG00008298	
8	O ring large	2	10112402	
9	O ring medium	1	10112401	
10	O ring small	1	10112400	
11	Nut Adaptor	1	10112399	
12	Pump shaft	1	10112398	
13	Bolts	8	10112403	
14	Washers	8	10112404	

Description	Qty Per Axle	Part Number		The Kit includes:
		D170	D190 / D590	
Complete Pump Kit	1	10086645P	10169754	All
Service Kit	1	10086645-SER	10169756-SER	1,2,3,4,5,7,8,9,10,12
Hose Kit	1	D170FLHOSEKIT	D190FLHOSEKIT	4,5

Item	Part Number	Quantity	Part Name
2	10112393	1	Gerotor (Pump Body)
15	10112395	1	Bushing
16	10122105	2	Pin - Dowel

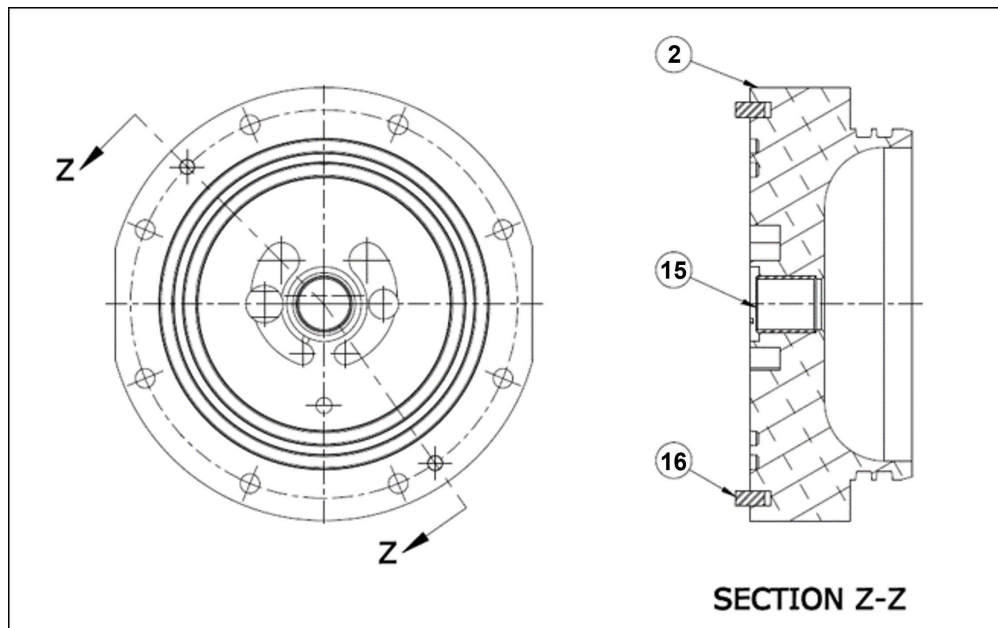

**Note:** Please check the Axle Tech Bulletin **DA0621001** for fitting instructions

For the rest of the axle refer to the Service Manual **AXSM0057**

If you have any questions, please call Dana Australia on **1300 003 262** or e-mail [aus.spicer@dana.com](mailto:aus.spicer@dana.com) for more information.